

PH-74

Bone Scintigraphy Quality Assurance Phantom

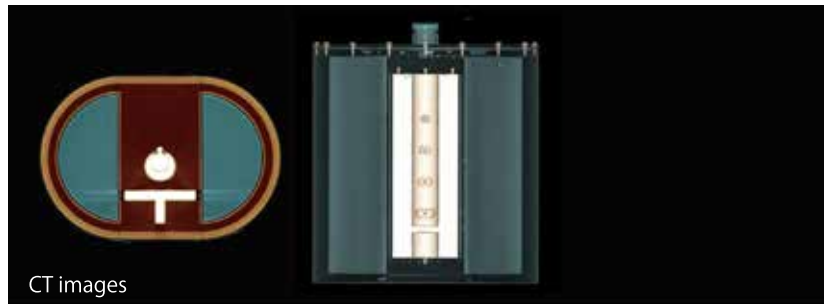

SPECT images

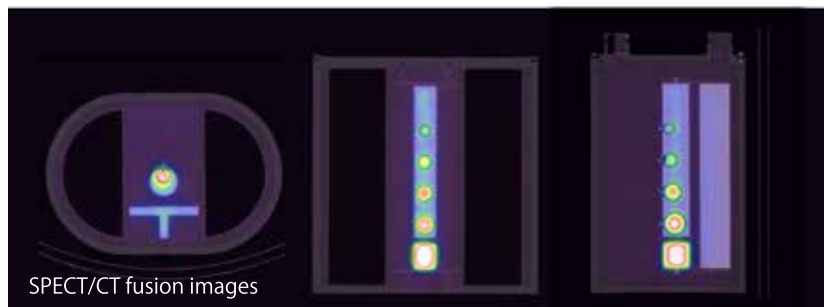

An innovative QA phantom for Bone Scintigraphy, Bone SPECT/CT and NaF-PET

The phantom is designed to represent both thoracic and lumbar regions by changing background materials.

- Thoracic region: fill the side cavities with the lung inserts.
- Lumbar region: fill the side cavities with soft tissue substitute solution.

Specifications

■ Evaluation Parameters

Visual Evaluation

- Tumor detectability
- Image distortion
- Artifact

Automated Evaluation

- Contrast and count ratio between vertebral body and tumor
- Concentration linearity and recovery coefficient in the tumor
- Statistical noise
- FWHM at the spinous process (relative index of resolution)

Other Evaluation

- Verification of scattering correction and attenuation correction

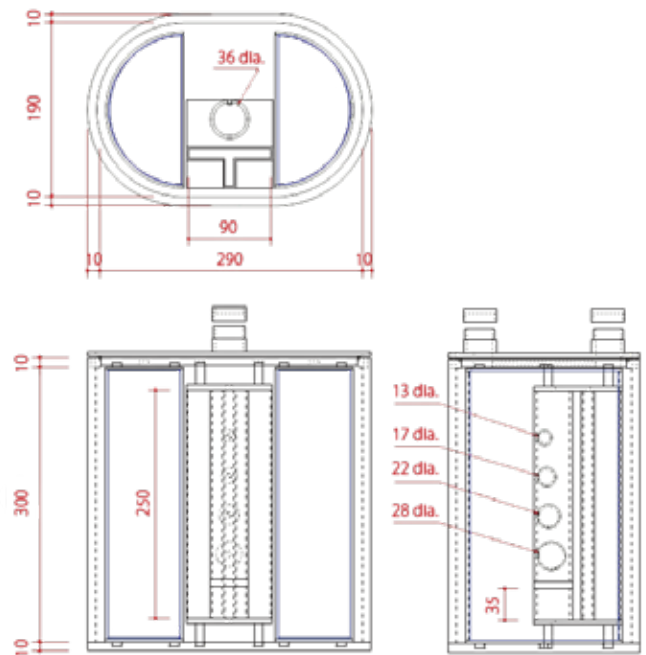

- Outer Dimensions: 310 x 210 x 355 mm
- Inner Dimensions: 290 x 190 x 300mm

- Material: Acrylic resin
- Tough lung (PVA acetal compound)



Specifications are subject to change without prior notice.



 **KYOTO KAGAKU co.,LTD**

 <http://www.kyotokagaku.com>
 rw-kyoto@kyotokagaku.co.jp



Hong Kong Representative Office

Level 60, One Island East,
18 Westlands Road, Island East, Hong Kong
 +852-3978-1365  +852-3978-1199



Worldwide Inquires and Ordering Head Office and Factories

15 Kitanechoya-cho, Fushimi-ku,
Kyoto, 612-8388, Japan
 +81-75-605-2510  +81-75-605-2519



European Representative Office

De-Saint-Exupery-Str.10,
60549 Frankfurt, Germany
 +49-69-5060-28160  +49-69-5060-28170

 All American regions
KYOTOKAGAKU AMERICA INC.

 <http://www.kkamerica-inc.com/>
 info@kkamerica-inc.com
* United States only

3109 Lomita Boulevard, Torrance,
CA 90505-5108, USA

 +1-310-325-8860
 +1-310-325-8867